

18 T-Slots
(Figure D)

6-M16
Cap-Screw hole
(Figure A)

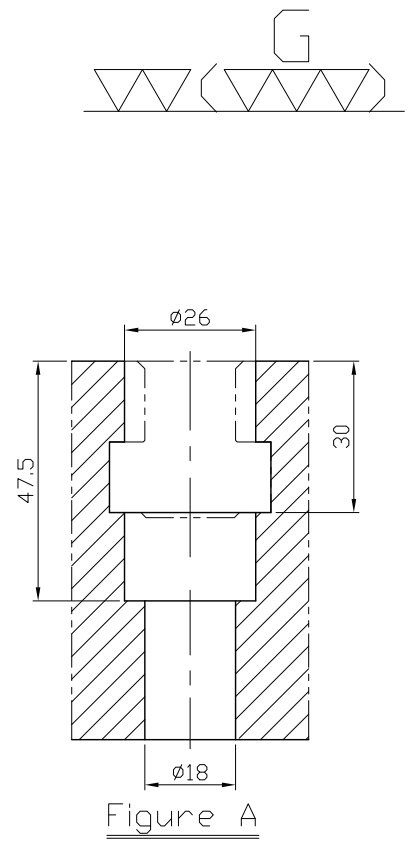
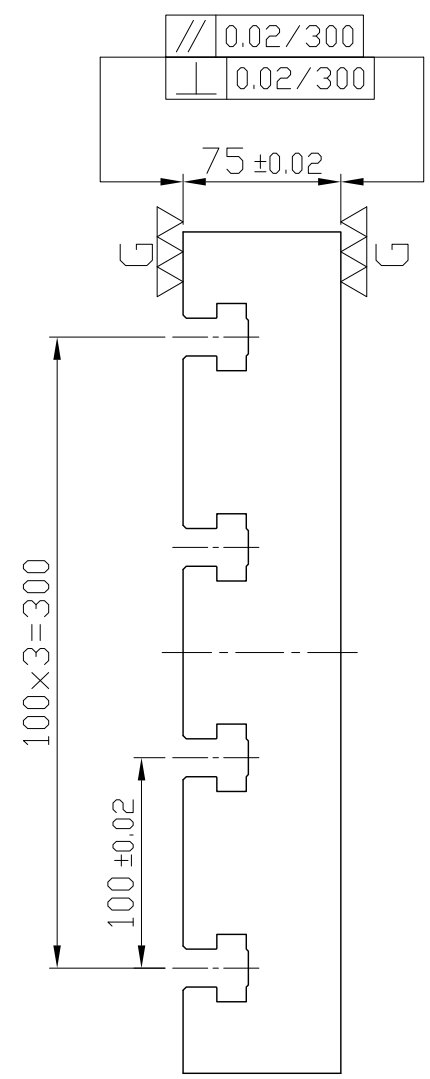
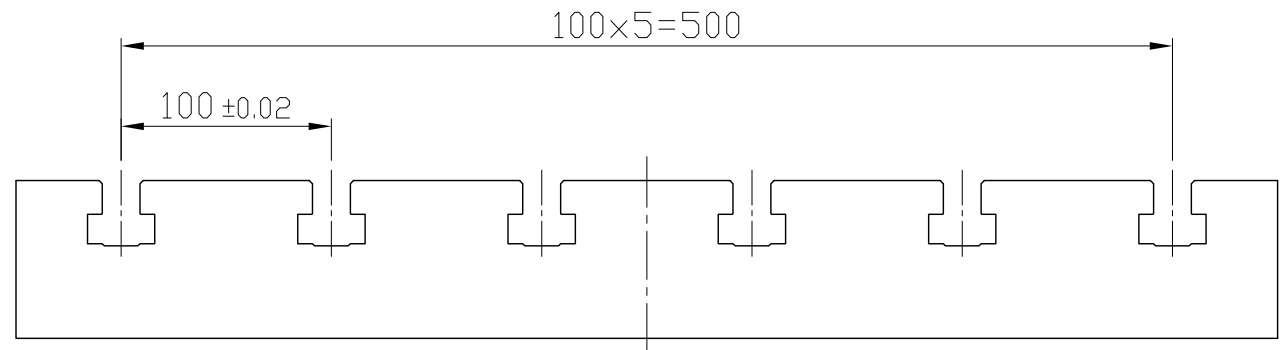

Figure A

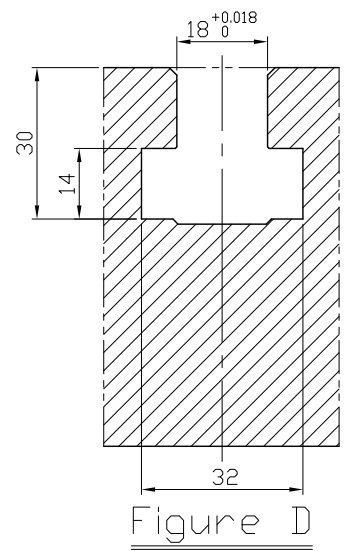

Figure D

*Edge chamfered C2

NW:118KG

Material FC300		Heat treatment Annealing Process		Surface treatment		
Drafted by S.C.H	Checked by	Approved by	Scale 1/1	Date 2011.10.15	Sheet 1/1	Edition A
			TITLE M/C BASE PLATE			
			DWG.ND. BP03-75400-0600-18			