

1 2 3 4 5 6 7 8 9 10 11 12 13 14 15 16 17 18 19 20

A
B
C
D
E
F
G
H
I
J
K
L
M
N
O
P
Q
R
S
T
U
V
W
X
Y
Z
AA
AB

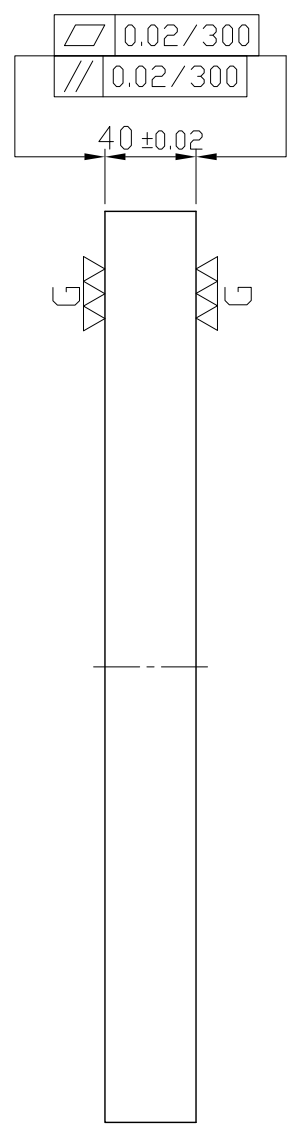

4-M12
Cap-Screw hole
(Figure A)

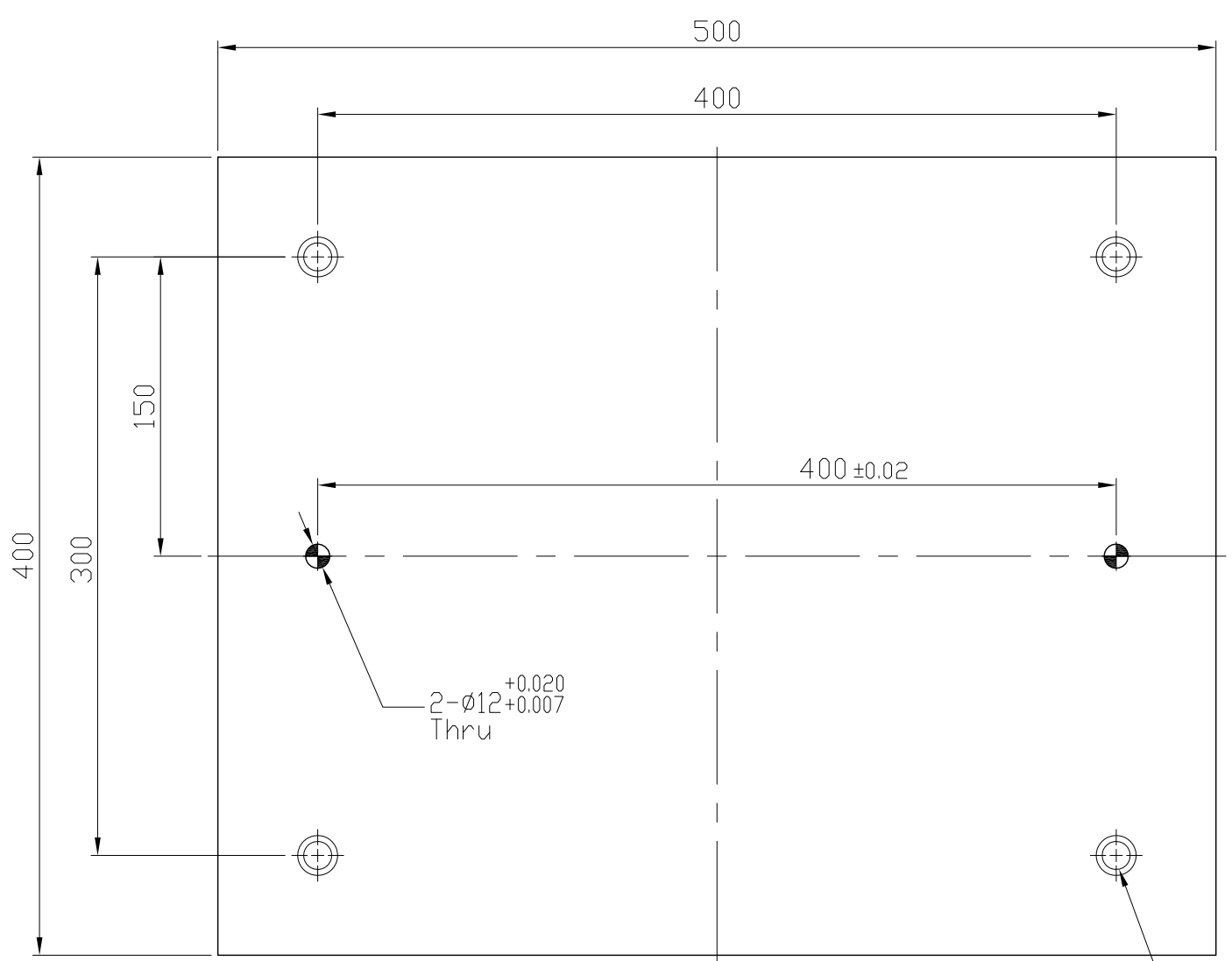
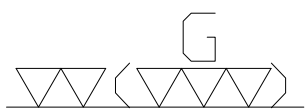
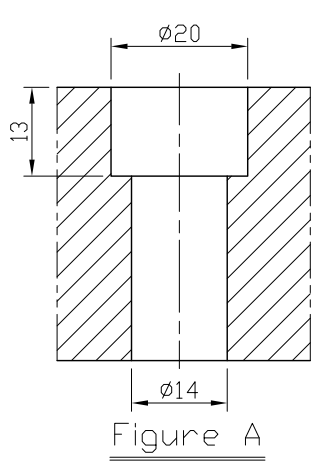

*Edge chamfered C2

NW:58KG

Material FC300		Heat treatment Annealing Process			Surface treatment		
Drafted by S.C.H	Checked by	Approved by		Scale 1/1	Date 2012.01.12	Sheet 1/1	Edition A
LEAVE INDUSTRIAL CO., LTD.			TITLE SUB-PLATE				
			DWG.ND. BP19-40400-0500-12				

1 2 3 4 5 6 7 8 9 10 11 12 13 14 15 16 17 18 19 20