

6-M16
Cap-Screw hole
(Figure A)

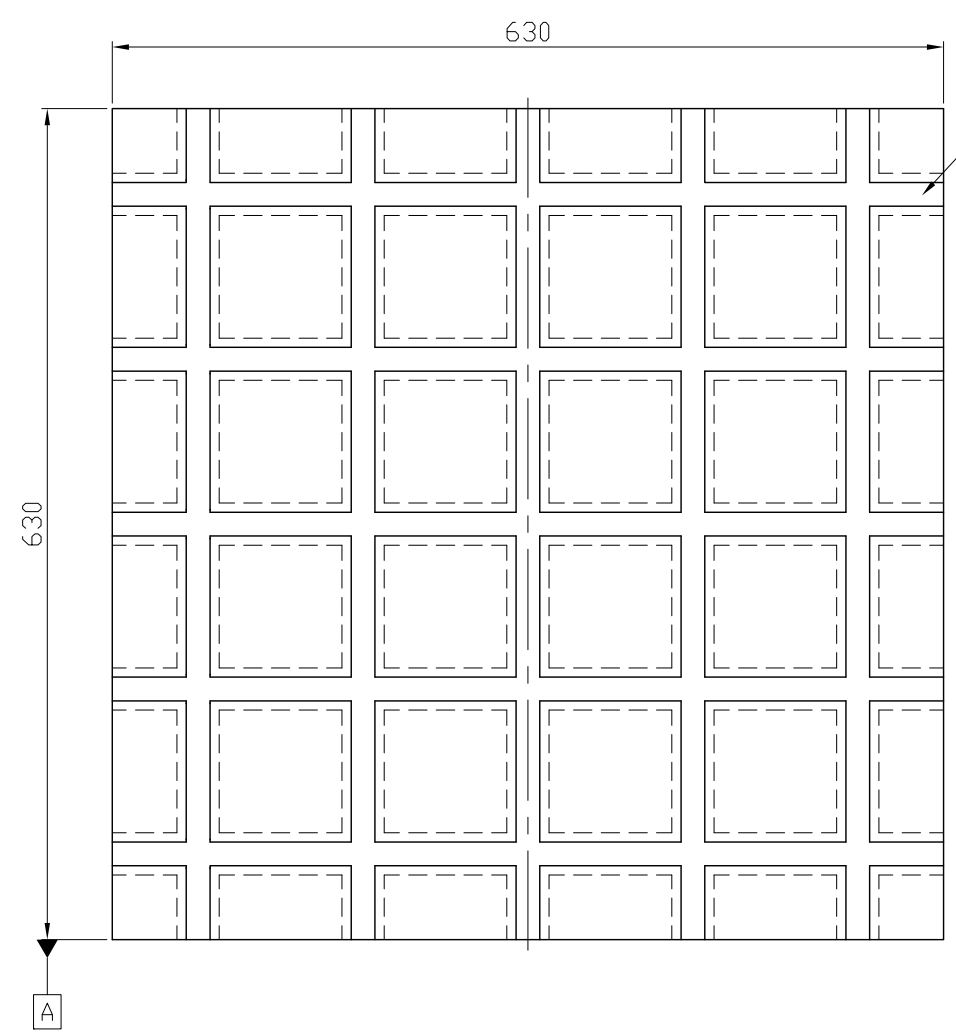

18 T-Slots
(Figure D)

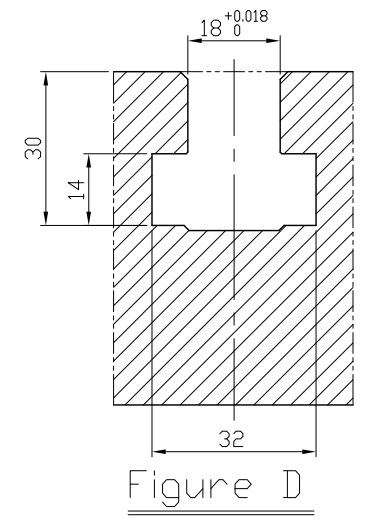
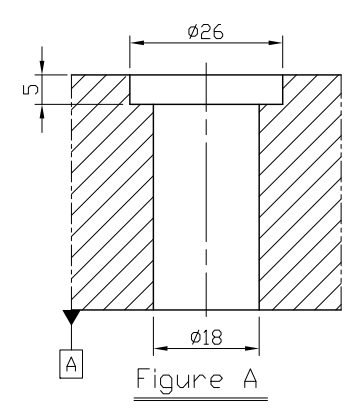
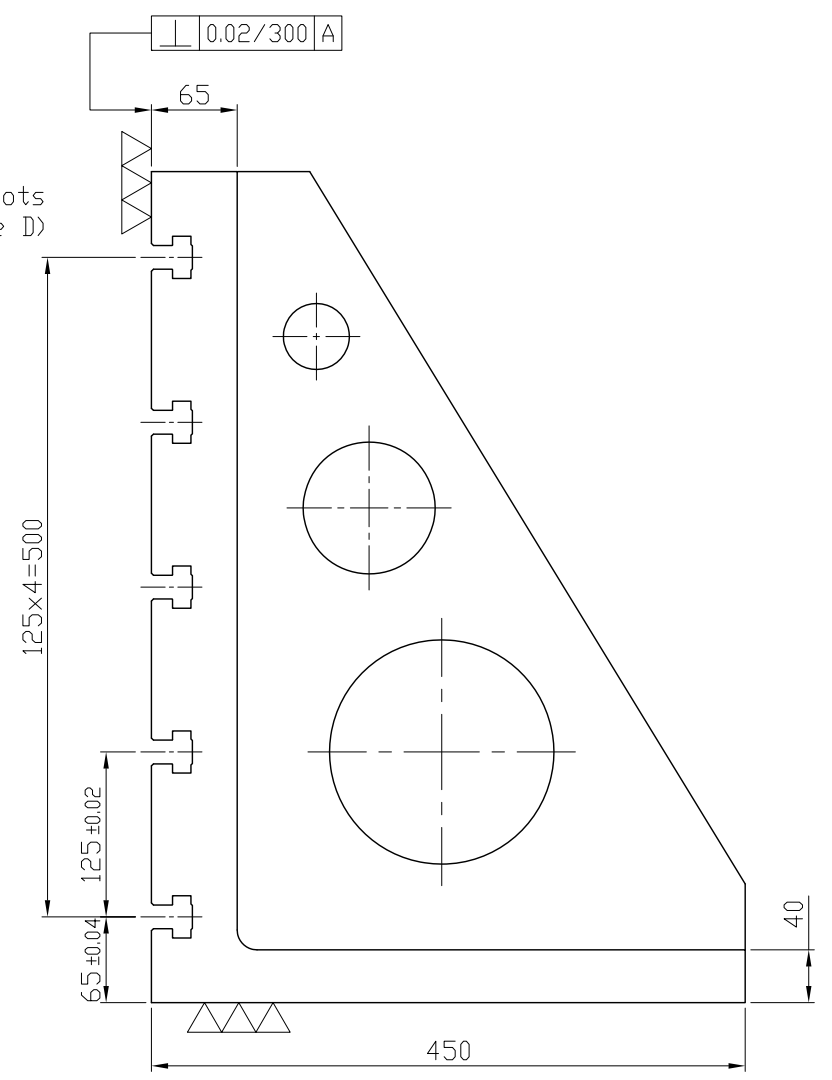

*Edge chamfered C2

NW:285KG

Material FC300		Heat treatment Annealing Process			Surface treatment		
Drafted by S.C.H	Checked by	Approved by	Scale 1/1	Date 2011.12.12	Sheet 1/1	Edition A	
LEAVE INDUSTRIAL CO., LTD.			TITLE ANGLE PLATE				
			DWG.NO. BP22-450630-0630-18				